



International Specification for Sprint Orienteering Maps (ISSOM)

Valid from 1 January 2007



FOREWORD

The Map Commission of the International Orienteering Federation is responsible for all matters related to orienteering maps within the IOF, such as map standardisation, development, education and quality assurance.

The ISSOM project started in 2001, as a result of the Leibnitz Convention, which introduced the sprint discipline into the World Orienteering Championships (WOC) programme.

Sprint orienteering introduce new mapping challenges. We have previously had park maps, but sprint events can take place in forests, in urban areas and in mixed environments. To establish a mapping standard for this new discipline has proven much more complicated than for traditional orienteering.

The Map Commission issued draft versions of the ISSOM in 2003 and 2004 and the opinions of the participants in the sprint discipline of the WOC in those years were sought. Their responses and those of National Federations was invaluable in producing the final version of the ISSOM in 2005.

Since the publication of the 2005 version several smaller issues have been discovered, such as textual inconsistencies and grammatical errors. We hope that most of these have been fixed in this 2006 update. A clarification has been made for symbol *step or edge of paved area* (529.1): Steps shall always be represented with a 0.07 mm line. The symbol *dangerous area* (710) has been removed. The symbol *out-of-bounds area* (709) shall be used also for dangerous areas.

Ås / Budapest, 1 October 2006

*Håvard Tveite (chairman), Thomas Gloor (project leader), László Zentai
MC members: Sergio Grifoni, Flemming Hjorth Jensen, Jukka Liikari, Erik E. Peckett*

1 INTRODUCTION

The sprint orienteering format has been defined by the IOF as follows:

- Sprint orienteering is a fast, visible, easy-to-understand format, allowing orienteering to be staged within areas of significant population. The sprint profile is high speed. Sprint is built on very high speed running in very runnable parks, streets or forests. The winning time, for both women and men, shall be 12-15 minutes, preferably the lower part of the interval.

The main characteristics of the ISSOM:

- ISSOM is based on the ISOM2000; but competitors and mapmakers must understand that sprint maps are special maps.
- Many of the requirements in ISOM2000 will also apply to Sprint maps.
- The most important difference between ISOM2000 and ISSOM is that thick black lines are now only used for uncrossable features. To ensure fairness it has been decided that features which are mapped uncrossable (e.g. walls, fences, cliffs, water and hedges) are also forbidden to cross.

Sprint orienteering differs from the longer established forms of foot orienteering. Whilst foot orienteering events traditionally have been staged mainly in forested areas, sprint events can be staged in any type of terrain. The use of parks and urban terrain in particular has important advantages: it brings the sport to where people are, and offers opportunities for increasing public and media awareness of orienteering, in accordance with the objectives of the Leibnitz Convention.

The expansion from classical forested terrain into parks and urban terrain presents new challenges in orienteering cartography. The current international specification for orienteering maps (ISOM 2000) contains symbols that are suitable for representing forested terrain. However, to ensure fair sprint orienteering competitions, the symbol set needs revision and extension in order to better accommodate parks and urban terrain. There are a number of reasons why the cartographic representation of terrain for sprint orienteering requires a different approach compared to that used for representation of 'classical' forested terrain. These include:

- Many more restrictions affecting route choice have to be considered in parks and urban terrains, such as physical barriers and areas with forbidden access.
- The amount of significant detail in urban terrain, particularly in the centre of old towns, is often much greater than in a forested terrain.
- Not only must the new types of terrain be considered when making the sprint map specification but also the purpose of the map – sprint orienteering – must be taken into account.
- To achieve fairness, it is necessary for mapmakers and course planners to collaborate more closely than for other disciplines.
- The correct mapping of reduced running speed, both to degree and extent, is extremely important for sprint orienteering because of the short winning times.
- In urban areas, it is not unusual to find multilevel areas. ISSOM allows for the representation of simple underpasses and overpasses. More complex multilevel areas which cannot be mapped clearly are not suitable for IOF events.

Due to these restrictions and constraints, principles have been settled for the International Specification for Sprint Orienteering Maps (ISSOM), which in some respects deviate significantly from those of the ISOM 2000.

Only symbols that are listed in Chapter 5 (ISSOM), may be used for Sprint Orienteering maps.

The ISSOM must therefore be treated as a specification in its own right.

2 PRINCIPLES

2.1 Map legibility

Map legibility depends on the chosen map scale and a well-chosen set of symbols as well as the application of generalisation rules. The ideal representation would be realised if every feature could be represented in true shape. Obviously, this is impossible, and an effort to draw each feature true to scale would result in a map impossible to read even with the aid of a magnifying glass. Depending on the chosen map scale, some symbols must represent features and be exaggerated in size, often far beyond the actual ground limits of the feature represented. In addition, not all features are essential for the purpose of the map, or as Eduard Imhof, a famous Swiss cartographer, stated:

'A map with few well chosen features will give a much better map than a map cluttered with many insignificant features'.

Features that are important for navigation, indicate runnability, or which shall not be crossed in sprint orienteering, have been listed in Chapter 5. Features that are not important for a competitor taking part in a sprint orienteering event should not be mapped. Examples of this are waste baskets, fire hydrants, parking meters and individual street lights.

To ensure legible maps, the ISSOM symbol set has been tried out in a number of test prints to provide a well balanced set of symbols that are clearly distinguishable in their size, line width, line type and colouring. In the end, it is the mapmaker's task to produce precise and legible sprint orienteering maps by applying these specifications and generalisation rules, such as selection, simplification and exaggeration.

2.2 Barriers - Black line width is used to show passability

- Barriers, such as high walls, high fences and high rock faces, affect route choices and shall be represented unambiguously. Therefore, these features shall be represented with a prominent thick black line.
- Obstacles which can be crossed, such as fences and small rock faces, are represented with a significantly thinner black line than the barrier features.
- Features which can be crossed very easily, such as steps and edges of paved areas, are represented with a very thin black line.

This principle makes it impossible to use the road and track symbols of ISOM 2000 in an unmodified form. The large scale of sprint orienteering maps makes it possible for roads and vehicle tracks to be represented in their true shape.

Hence, thick black lines are, in these specifications, used to represent barriers, which cannot or shall not be crossed.

2.3 Barriers that are forbidden to cross

To make sprint orienteering fair to all competitors, features that are represented on the map as impassable, independently of their effective passability, shall not be crossed.

This rule is essential for two reasons:

- It is impossible to declare an exact height when an obstacle becomes impassable. Effective passability depends very much on the physical characteristics of the competitors such as body height and strength. If features represented as barriers on the map are declared as forbidden to cross, the conditions are the same for all.
- Crossing of certain areas and linear features in parks and urban terrain may be forbidden by law.

Running and navigational skills should be the success factors for competitors in a race, rather than luck when it comes to climbing or jumping barriers or violating public law.

Consequently, competitors who do not obey this rule, which is part of the IOF competition rules, must be disqualified.

2.4 Traffic must be kept out of sprint orienteering areas

Traffic that can influence the results cannot be allowed in a competition area for sprint orienteering, for fairness and safety reasons.

A collision between a person and a car, even at a moderate speed, can cause injury or death. Neither drivers nor competitors are fully aware of each other during a competition. Car traffic makes serious accidents possible, and this must be avoided in orienteering events.

It is not possible to represent the variable characteristics of traffic volumes that affect the route choice of the competitor on an orienteering map. It is therefore not possible to guarantee fair conditions for all competitors with traffic in the terrain. Therefore, sprint orienteering events shall be staged only where traffic can be kept out.

The organisers should consider the following measures:

- Halting of traffic (closing of roads).
- Restricting traffic (controlled by policemen).
- Construction of temporary overpasses (e.g. bridges).
- Separating competitors from pedestrians and spectators by the use of tape or barriers.

If such measures are necessary but not possible then the chosen area is not suitable for sprint orienteering.

2.5 The main 'running' level of multilevel structures should be represented

Multilevel structures such as bridges, canopies, underpasses or underground buildings are common in urban areas. The cartographic representation of more than one level is in general impossible. Hence only the main 'running' level should be represented on the map. However, underground passages

(e.g. underpasses, lighted tunnels) or overpasses (e.g. bridges), which are important for the competitors should be represented on the map.

2.6 Collaboration between course planner and mapmaker

The restrictions and constraints of sprint orienteering must be taken seriously by the organizers and course planners. In particular:

- Both mapmaker and course planner should consider all possible route choices and make decisions on impassable features and out-of-bounds areas.
- The course planner should not encourage unfair actions from the competitors, such as crossing barriers or areas with forbidden access. If it is unavoidable to set legs that cross or skirt areas with forbidden access or impassable walls and fences, then they have to be marked in the terrain, and observers should be present at the critical points.
- Control points shall not be placed under or above the main 'running' level.

3 BASIC ELEMENTS

3.1 Scale

The map scale shall be either 1:4 000 or 1:5 000. The scales 1:5 000 and 1:4 000 are suitable for the sprint format. They allow course lengths up to 4.0 km with a handy map format. A scale of 1:5 000 is suitable for most terrains. However, the level of detail in some urban terrains, particularly in the centre of old towns with lots of essential features (e.g. stairs, narrow alleys or small passages) may be better suited to a scale of 1:4 000. The size of the symbols is the same for both scales.

3.2 Contour interval

The contour interval value shall be either 2 m or 2.5 m for both 1:5 000 and 1:4 000. The contour is the most important element in the cartographic representation of the terrain and the only one which determines relief forms geometrically.

The brownness (percentage of brown) is the most important indicator of the slope of the ground for the competitor. Contour interval, contour line width and map scale should therefore be balanced in order to obtain maps with similar brownness for the same terrain using all foot orienteering map specifications. The ISSOM contour interval has been chosen to correspond with the ISOM contour interval regarding brownness (taking into account line width and scale).

3.3 Dimensions of map symbols

No deviations from the given dimensions within these specifications are permitted. It is however accepted that due to limitations in printing technology the final map symbol dimensions may vary up to +/-5%.

Dimensions in this book are given at the printed scale of 1:5 000 and 1:4 000.

All line widths and symbol dimensions must be kept strictly to their specified value. Certain minimum dimensions must also be observed. These are based on both printing technology and the need for legibility.

MINIMUM DIMENSIONS

- Gap between two line symbols of the same colour, in brown or black: 0.15 mm, in blue: 0.25 mm
- Gap between line symbols and area symbols of the same colour, in black: 0.15 mm
- Shortest dotted line: at least two dots
- Shortest dashed line: at least two dashes
- Smallest area enclosed by a dotted line: 1.5 mm (diameter) with 5 dots
- Smallest area of colour
 - Blue, green, grey or yellow full colour: 0.5 mm²
 - Black dot screen: 0.5 mm²
 - Blue, brown, green or yellow dot screen: 1.0 mm²

All features smaller than the dimensions above must be either exaggerated or omitted, depending on whether or not they are of significance to the competitor. When a feature is enlarged, neighbouring features must be displaced so that the correct relative positions are maintained.

SCREENS

Vegetation, open areas, marshes, etc. are shown with dot or line screens. The following table lists the permissible combinations of screens.

Symbol	Permitted combinations
117 Broken ground	117 Broken ground
210 Stony ground	210 Stony ground
309 Impassable marsh	309 Impassable marsh
310 Marsh	310 Marsh
311 Indistinct marsh	311 Indistinct marsh
401 Open land	401 Open land
402 Open land with scattered trees	402 Open land with scattered trees
403 Rough open land	403 Rough open land
404 Rough open land with scattered trees	404 Rough open land with scattered trees
406 Forest: slow running	406 Forest: slow running
407 Undergrowth: slow running	407 Undergrowth: slow running
408 Forest: difficult to run	408 Forest: difficult to run
409 Undergrowth: difficult to run	409 Undergrowth: difficult to run
410 Vegetation: very difficult to run	410 Vegetation: very difficult to run

Other symbols (like 211, 410, 411, 412, 413, 421, 528.1, 529) cannot be combined with other symbols.

3.4 Format of the map

The map format should not exceed DIN A4.

3.5 Colour Concept

The 7-colour concept of ISOM2000 is also to be adopted for Sprint Orienteering maps. Thus, colour combinations of black, brown, yellow, blue, green and grey are possible, in addition to purple overprint.

4 PRINTING

A sprint orienteering map must be printed on good, possibly water resistant, paper (weight 80-120 g/m²). Spot colour printing is recommended for IOF events. Other printing methods may be used, if colours and lines have the same quality as printing with spot colours and the durability and the water resistance of the paper and colours is satisfactory. Legibility depends on the correct choice of colours and paper. To improve the legibility one should use the highest screen frequency for dot screens that is available and technically feasible (60 lines/cm is the minimum).

4.1 Spot colour printing

Spot colour printing uses pure colour inks. Each spot colour ink is made by mixing a number of stock inks in specific proportions to produce the desired colour. The colours specified for use for orienteering maps are defined by the Pantone Matching System (PMS).

The map may be in up to 6 colours (excluding overprinting).

The following recommendations for spot colours are intended to standardize maps as much as possible:

Colour	PMS number
Black	black
Brown	471
Yellow	136
Blue	299
Green	361
Grey	428
Purple	purple

The appearance of colours is dependent on the printing order.

In spot colour printing, the printing order should always be:

- yellow
- green
- grey
- brown
- blue
- black
- purple (overprint)

4.2. Four-colour printing

Four-colour printing is the traditional way of printing most colour work. Maps have been one of the main exceptions due to the fine line requirements. The four-colour printing method uses the three basic colours of the subtractive colour model: cyan, magenta and yellow. In theory, a mix of 100% of cyan, magenta and yellow produces black colour, but in reality it will be more of a dark brown. Therefore black is normally printed as a separate colour. After these four colours the model is often referred to as CMYK.

The use of digital techniques to produce four-colour separations has now made it possible to make high quality orienteering maps using four-colour printing. This is not the suggested method of printing orienteering maps, it is an alternative. This method will only be acceptable when line quality, legibility and colour appearance are of the same quality as (or better than) the traditional spot colour printed map.

5 DEFINITION OF SYMBOLS

Note: dimensions are specified in mm.

All drawings are in double scale for clarity only.

The size of the symbols is the same for both scales.

See Chapter 6 for more details.

<	gap or infill between two lines
-	line thickness
-	length, height or distance from centre to centre of baseline, generally the length of tags are measured to the centre of the baseline
o	diameter
↑	the symbol is orientated to north
For all point symbols, location is at the centre of gravity of the symbol.	

5.1 LAND FORMS

101 Contour

A line joining points of equal height. The standard vertical interval between contours is 2 or 2.5 m. To emphasize the 3-dimensional effect of the contour line image, contour lines shall be represented as continuous lines through all symbols, also *building* (526.1) and *canopy* (526.2). However, contour lines shall be cut out for better legibility, if they touch the following symbols: *small earth wall* (108.1), *small knoll* (112), *small elongated knoll* (113), *small depression* (115), *pit or hole* (116), *prominent landform feature* (118), *step or edge of paved area* (529.1). The relative height difference between neighbouring features must be represented on the map as accurately as possible. Absolute height accuracy is of less importance. It is permissible to alter the height of a contour slightly if this will improve the representation of a feature. This deviation should not exceed 25% of the contour interval and attention must be paid to neighbouring features. The smallest bend in a contour is 0.4 mm from centre to centre of the lines.

Colour: brown.

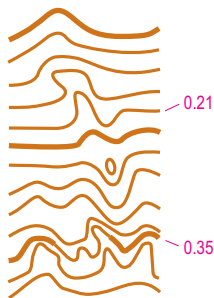

102 Index contour

Every fifth contour shall be drawn with a thicker line. This is an aid to the quick assessment of height difference and the overall shape of the terrain surface. Where an index contour coincides with an area of much detail, it may be shown with symbol *contour* (101).

Colour: brown.



103 Form line

An intermediate contour line. Form lines are used where more information can be given about the shape of the ground. They are used only where representation is not possible with ordinary contours. Only one form line may be used between neighbouring contours.

Colour: brown.

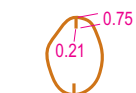

104 Slope line

Slope lines should be drawn on the lower side of a contour line where it is necessary to clarify the direction of slope, e.g. along the line of a re-entrant or in a depression.

Colour: brown.

105 Contour value

Contour values may be included to aid assessment of large height differences. The figures shall be orientated so that the top of the figure is on the higher side of the contour. They are inserted in the index contours in positions where other detail is not obscured.

Colour: brown.

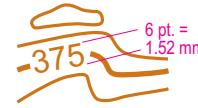

106 Earth bank

A steep earth bank is an abrupt change in ground level which can be clearly distinguished from its surroundings, e.g. gravel or sand pits, roads and railway cuttings or embankments. The tags should show the full extent of the slope, but may be omitted if two banks are close together. Impassable banks shall be drawn with the symbol *impassable cliff* (201). The line width of very high earth banks may be 0.37 mm.

Colour: brown.

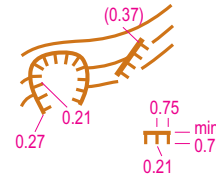

108.1 Small earth wall

A small distinct earth wall, usually man made. The minimum height is 0.5 m. Larger earth walls should be represented with the symbols *contour* (101), *form line* (103) or *earth bank* (106).

Colour: brown.

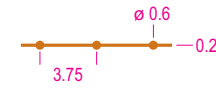

109 Erosion gully or trench

An erosion gully or trench which is too small to be represented with the symbol *earth bank* (106), *contour* (101), *index contour* (102) or *form line* (103) is represented by a single line. The line width reflects the size of the gully. The end of the line is pointed. Minimum depth is 1 m. Minimum length is 3 mm on the map.

Colour: brown.

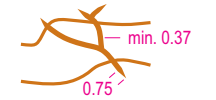

110 Small erosion gully

A small erosion gully or trench. Minimum depth is 0.5 m.

Colour: brown.

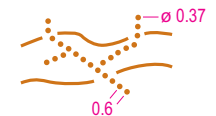

112 Small knoll

A small obvious mound or rocky knoll which cannot be drawn to scale with a *contour* (101), *index contour* (102) or *form line* (103). The height of the knoll should be a minimum of 1 m from the surrounding ground.

Colour: brown.

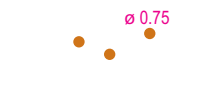

113 Small elongated knoll

A small obvious elongated knoll which cannot be drawn to scale with a *contour* (101), *index contour* (102) or *form line* (103). The maximum length should be 6 m and the maximum width 2 m. The height of the knoll should be a minimum of 1 m from the surrounding ground. Knolls larger than this shall be shown by contours. The symbol may not be drawn in free form or such that two elongated knoll symbols touch or overlap.

Colour: brown.



115 Small depression

A small shallow natural depression or hollow which cannot be represented by the symbol *contour* (101) or *form line* (103) is represented by a semicircle. The minimum diameter should be 2 m. The minimum depth from the surrounding ground should be 1 m. The symbol is orientated to north. Colour: brown.



116 Pit or hole

A pit or hole with distinct steep sides which cannot be represented to scale with the symbol *earth bank* (106). The minimum diameter shall be 2 m. The minimum depth from the surrounding ground shall be 1 m. The symbol is orientated to north. Colour: brown.

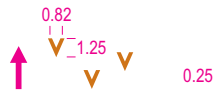

117 Broken ground

An area of pits or knolls, which is too complex to be represented in detail. The density of randomly placed dots may vary according to the detail on the ground. Colour: brown.



118 Prominent landform feature

A small landform feature which is significant or prominent. The definition of the symbol shall always be given in the map legend. The symbol is orientated to north. Colour: brown.



5.2 ROCK AND BOULDERS

201 Impassable cliff (forbidden to cross)

An impassable cliff, quarry or earth bank (see symbol *earth bank* 106). Tags are drawn downwards, showing its full extent from the top line to the foot. For vertical rock faces the tags may be omitted if space is short, e.g. narrow passages between cliffs (the passage should be drawn with a width of at least 0.3 mm). The tags may extend over an area symbol representing detail immediately below the rock face. When a rock face drops straight into water making it impossible to pass under the cliff along the water's edge, the bank line is omitted or the tags shall clearly extend over the bank line. Minimum height is 2 meters.

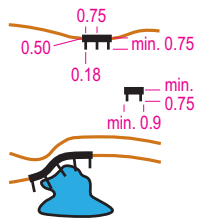

Colour: black.

It is forbidden to cross an impassable cliff!

Competitors violating this rule will be disqualified.

202 Gigantic boulder or rock pillar

A gigantic boulder, rock pillar or massive cliff shall be represented in plan shape without tags. Colour: black.



203 Passable rock face

A small vertical rock face may be shown without tags. If the direction of fall of the rock face is not apparent from the contours or to improve legibility, short tags should be drawn in the direction of the fall. Minimum height is 1 m. For passable rock faces shown without tags the end of the line may be rounded to improve legibility. Colour: black.

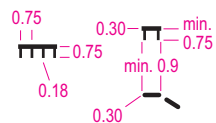

204 Rocky pit

A rocky pit, hole or mineshaft which may constitute a danger to the competitor. The symbol is orientated to north. Colour: black.



205 Cave

A cave is represented by the same symbol as a rocky pit. In this case the symbol shall be orientated to point up the slope as indicated opposite. This symbol should generally not be used in urban areas. The centre of gravity of the symbol marks the opening. Colour: black.

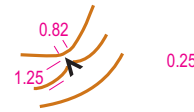

Controls may not be placed inside caves!

206 Boulder

A small distinct boulder. The minimum height is 1 m. Every boulder marked on the map shall be immediately identifiable on the ground. Colour: black.

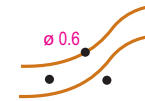

207 Large boulder

A particularly large and distinct boulder. Gigantic boulders shall be represented in plan shape with the symbol *gigantic boulder or rock pillar* (202). Colour: black.



208 Boulder field

An area which is covered with so many blocks of stone that they cannot be marked individually is represented with randomly orientated solid triangles. The runnability is reduced and is indicated by the density of the triangles. A minimum of two triangles shall be used. The triangles can be enlarged by up to 20%. Colour: black.

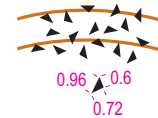

210 Stony ground

An area of stony or rocky ground which reduces runnability. The dots shall be randomly distributed with density according to the amount of rock. A minimum of three dots shall be used. Colour: black.



211 Open sandy ground

An area of soft sandy ground or gravel with no vegetation which reduces runnability. Where an area of sandy ground is open and has good runnability, it is represented with symbol *open land* (401), *open land with scattered trees* (402) or *paved area* (529). Colour: black 12.5% (22 lines/cm) and yellow 50%.



212 Bare rock

An area of runnable rock without earth or vegetation. An area of rock covered with grass, moss or other low vegetation shall be represented according to its openness and runnability (401/402/403/404). Colour: black 20% (min. 60 lines/cm) or grey.



5.3 WATER AND MARSH



0.25

303 Waterhole

A water-filled pit or an area of water which is too small to be shown to scale. The symbol is orientated to north. Colour: blue.

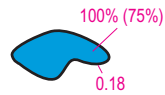

304.1 Impassable body of water (forbidden to cross)

An area of deep water such as a lake, pond, river or fountain which may constitute a danger to the competitor or has forbidden access. The dark blue colour and the bordering black line indicates that the feature cannot or shall not be crossed. The minimum dimension is 1 mm². Colour: blue 100% or 75% (min. 60 lines/cm), black. **It is forbidden to cross an impassable body of water! Competitors violating this rule will be disqualified.**

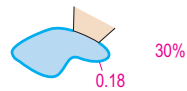

305.1 Passable body of water

An area of shallow water such as a pond, river or fountain that can be crossed. The body of water shall be less than 0.5 m deep and runnable. If the body of water is not runnable it shall be represented with the symbol *impassable body of water* (304.1). If no other line symbol touches the border of the passable body of water, the border shall be represented with a blue line. Colour: blue 30% (min. 60 lines/cm), blue.



0.21

306 Passable small watercourse

A crossable watercourse less than 2 m wide. Colour: blue.



0.21

307 Minor watercourse

A natural or man-made minor watercourse which may contain water only intermittently. Colour: blue.



308 Narrow marsh

A marsh or trickle of water which is too narrow to be shown with symbol *marsh* (310). Colour: blue.



309 Impassable marsh (forbidden to cross)

A marsh which is impassable or which may constitute a danger to the competitor. The feature cannot or shall not be crossed. Colour: blue, black. **It is forbidden to cross an impassable marsh! Competitors violating this rule will be disqualified.**



310 Marsh

A crossable marsh, usually with a distinct edge. The symbol shall be combined with vegetation symbols to show runnability and openness. Colour: blue.

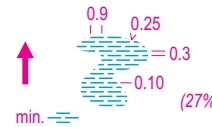

311 Indistinct marsh

An indistinct or seasonal marsh or area of gradual transition from marsh to firm ground, which is crossable. The edge is generally indistinct and the vegetation similar to that of the surrounding ground. The symbol shall be combined with vegetation symbols to show runnability and openness. Colour: blue.



0.25

312 Small fountain or well

Small well or fountain, which is at least 1 m high or at least 1 m in diameter. Colour: blue.



313 Spring

The source of a stream with a distinct outflow. This symbol should generally not be used in urban areas. The symbol is orientated to open downstream. Colour: blue.



314 Prominent water feature

A small water feature which is significant or prominent. The definition of the symbol shall always be given in the map legend. The symbol is orientated to north. Colour: blue.

5.4 VEGETATION



100%

401 Open land

An area of cultivated land, lawn, field, meadow, grassland, etc. without trees, offering very good runnability. Colour: yellow.

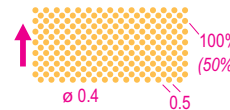

402 Open land with scattered trees

An area of meadows with scattered trees or bushes, with grass or similar ground cover offering very good runnability. Areas smaller than 10 mm² at the maps scale are shown as *open land* (401). Symbols *prominent large tree* (418) and *prominent bush or small tree* (419) may be added. Colour: yellow (20 lines/cm).



50%

403 Rough open land

An area of heath or moorland, a felled area, a newly planted area (trees lower than ca. 1 m) or other generally open land with rough ground vegetation, i.e. heather or tall grass. This symbol may be combined with symbols *undergrowth: slow running* (407) and *undergrowth: difficult to run* (409) to show reduced runnability. Colour: yellow 50% (min. 60 lines/cm).

404 Rough open land with scattered trees
 An area of rough open land with scattered trees or bushes.
 Areas smaller than 16 mm² in the map scale are either mapped as *rough open land* (403) or *forest: easy running* (405). Symbols *prominent large tree* (418) and *prominent bush or small tree* (419) may be added.
 Colour: yellow 70% (min. 60 lines/cm), white screen of 48.5%.

405 Forest: easy running
 An area of typical open runnable forest for the particular type of terrain. If no part of the forest is runnable then no white should appear on the map.
 Colour: white.

406 Forest: slow running
 An area with dense trees (low visibility) which reduces running to ca. 60-80% of normal speed.
 Colour: green 30% (min. 60 lines/cm).

407 Undergrowth: slow running
 An area of dense undergrowth but otherwise good visibility (brambles, heather, low bushes, cut branches, etc.) which reduces running to ca. 60-80% of normal speed. This symbol shall not be combined with the symbol *forest: slow running* (406) or *forest: difficult to run* (408).
 Colour: green.

408 Forest: difficult to run
 An area with dense trees or thicket (low visibility) which reduces running to ca. 20-60% of normal speed.
 Colour: green 60% (min. 60 lines/cm).

409 Undergrowth: difficult to run
 An area of dense undergrowth but otherwise good visibility (brambles, heather, low bushes, cut branches, etc.) which reduces running to ca. 20-60% of normal speed. This symbol shall not be combined with the symbol *forest: slow running* (406) or *forest: difficult to run* (408).
 Colour: green.

410 Vegetation, very difficult to run
 An area of dense vegetation (trees or undergrowth) which is barely passable. Running reduced 1-20% of normal speed.
 Colour: green 100%.

421 Impassable vegetation (forbidden to cross)
 An area of dense vegetation (trees or undergrowth) which is impassable or which shall not be crossed, due to forbidden access or because it may constitute a danger to the competitor.
 Colour: green 100%, black 50% (min. 60 lines/cm).
 It is forbidden to cross impassable vegetation!
 Competitors violating this rule will be disqualified.

411 Forest runnable in one direction
 When an area of forest provides good running in one direction but less good in others, white stripes are left in the screen symbol (406, 408, 410) to show the direction with good runnability.
 Colour: green, white.

412 Orchard
 Land planted with fruit trees or bushes. The dot lines may be orientated to represent the direction of planting.
 Colour: green, yellow.

413 Orchard, one direction (e.g. Vineyard)
 Land planted with fruit trees or bushes, with a distinct direction of planting which reduces the runnability. The green lines shall be orientated to show the direction of planting.
 Colour: green, yellow.

414 Distinct cultivation boundary
 The boundary of symbol *cultivated land (seasonally out of bounds)* (415) when not shown with other symbols (fence, wall, path, etc.) is represented with a black line. A permanent boundary between different types of cultivated land is also represented with this symbol.
 Colour: black.

415 Cultivated land (seasonally out of bounds)
 Cultivated land which is seasonally out-of-bounds due to growing crops may be shown with a black dot screen.
 Colour: yellow, black 5% (12.5 lines/cm).

416 Distinct vegetation boundary
 A distinct forest edge or very distinct vegetation boundary within the forest. For indistinct boundaries, the area edges are shown only by the change in colour and/or dot screen.
 Colour: black.

418 Prominent large tree
 A prominent single tree.
 Colour: green.

419 Prominent bush or small tree
 A bush or a tree with a trunk less than 0.5 m diameter.
 Colour: green.

420 Prominent vegetation feature
 A vegetation feature which is significant or prominent. The definition of the symbol shall always be given in the map legend. The symbol is orientated to north.

5.5 MAN-MADE FEATURES

506.1 Unpaved footpath or track

An unpaved footpath or rough vehicle track is a way for passing mainly by foot, without a smooth, hard surface. The density of the brown fill-in shall be the same as the density chosen for the symbol *paved area* (529).

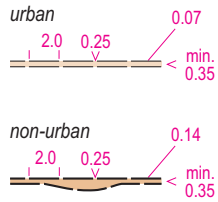

To improve the legibility of this symbol in non-urban parts of the map, the line width shall, in the non-urban parts of the map, be increased from 0.07 mm to 0.14 mm, and the brown fill-in shall, in the non-urban parts of the map, be drawn darker, so that if (x)% brown is used in urban parts of the map, (x+20)% brown shall be used in the non-urban parts of the map.

Colour: black, brown 0 (white), 10%, 20% or 30% (*urban*) / 20%, 30%, 40%, 50% (*non-urban*) (min. 60 lines/cm); the colour and the line width shall be the same as for the symbols *paved area* (529) and *step or edge of paved areas* (529.1).

507 Small unpaved footpath or track

A small unpaved footpath or track. Not to be used in urban areas. Colour: black.



508 Less distinct small path

A less distinct path or forestry extraction track. Not to be used in urban areas. Colour: black.

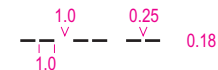

509 Narrow ride

A distinct ride is a linear break in the forest (usually in a plantation), which does not have a distinct path along it. Where there is a path along a ride, the symbol *small unpaved footpath or track* (507) shall be used. Not to be used in urban areas. Colour: black.

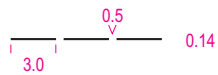

512.1 Bridge

A bridge is a structure spanning and permitting passage over a river, chasm, road or the like. Colour: black.



515.1 Railway

A railway is a permanent track laid with rails on which locomotives, carriages or wagons can travel. If it is forbidden to cross or run along the railroad, the forbidden area around the railway shall be represented with symbol *area with forbidden access* (528.1).

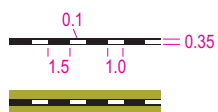

515.2 Tramway

A tramway is a public vehicle running regularly along certain streets, usually on rails. The track can be easily crossed by the competitor. Tramways are generally not represented. However, if they serve navigation or orientation, they can be represented.



Colour: black 50%.

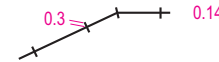

516 Power line, cableway or skilift

Power line, cableway or skilift. The bars indicate the exact location of the pylons. Colour: black.

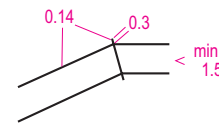

517 Major power line

Major power lines should be drawn with a double line. The gap between the lines may indicate the extent of the powerline. Very large carrying masts shall be represented in plan shape or with the symbol *high tower* (535). In this case, the cable lines can be left out (the map shows only the pylons).

Colour: black.

518.1 Underpass or tunnel

An underpass or a tunnel is a passage running underneath the ground, especially a passage for pedestrians or vehicles, crossing under for instance a railroad or a road.

Colour: black.

If underpasses or tunnels etc. are to be used in a competition, they shall be emphasized with the symbol *crossing point* (708) or *crossing section* (708.1)!

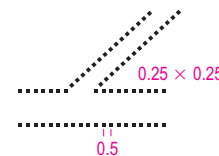

519 Passable stone wall

A stone wall or stone faced bank. This symbol shall be used only in non-urban areas. If such a wall is higher than 2 m, it shall be represented with the symbol *impassable wall* (521.1).

Colour: black.

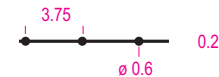

519.1 Passable wall

A passable wall or retaining wall is a construction made of stone, brick, concrete etc., which can be passed. This symbol is suitable for urban areas. If such a wall is higher than 2 m, it shall be represented with the symbol *impassable wall* (521.1). Wide walls shall be drawn in plan shape. Colour: black 50%.



521.1 Impassable wall (forbidden to cross)

An impassable wall or retaining wall is a wall, which fulfil the function of an enclosure or solid barrier. It shall not be crossed, due to forbidden access or because it may constitute a danger to the competitor due to its height. Very wide impassable walls shall be drawn in plan shape and represented with the symbol *building* (526.1).

Colour: black.

It is forbidden to cross an impassable wall!
Competitors violating this rule will be disqualified.



522 Passable fence or railing

A passable fence is a barrier enclosing or bordering a field, yard, etc., usually made of posts and wire or wood. It is used to prevent entrance or to confine or mark a boundary. A railing is a fence-like barrier composed of one or more horizontal rails supported by widely spaced upright poles, usually it can be slipped through.

If a fence or railing is higher than 2 m or very difficult to cross, it shall be represented with the symbol *impassable fence or railing* (524).

Colour: black.

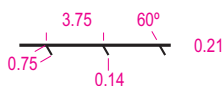

524 Impassable fence or railing (forbidden to cross)

An impassable fence or railing, which shall not be crossed, due to forbidden access or because it may constitute a danger to the competitor because of its height.

Colour: black.

It is forbidden to cross an impassable fence or railing!

Competitors violating this rule will be disqualified.

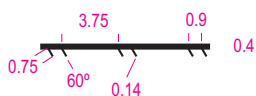

525 Crossing point

A crossing point is a gap or an opening in a fence, railing or wall, which can easily be passed through by a competitor.

Small gaps or openings which can not easily be passed through by competitors, shall not be represented on the map and shall be closed during the competition.

Colour: black.

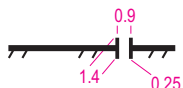

526.1 Building (forbidden to pass through or over)

A building is a relatively permanent construction having a roof. Buildings within symbol *area with forbidden access* (528.1) may just be represented in a simplified manner. Areas totally contained within a building shall be mapped as being a part of the building.

The minimum gap between buildings and between buildings and other impassable features shall be 0.40 mm.

The black screen percentage should be chosen according to the terrain. A dark screen gives a better contrast to passable areas, such as streets, stairways and canopies, while a light screen makes contours and course overprint more clearly visible (which can be important in very densely built up urban terrain and in steep urban terrain). The black screen shall be the same for the whole map.

Colour: black 50-65%, black.

It is forbidden to pass through or over a building!

Competitors violating this rule will be disqualified.

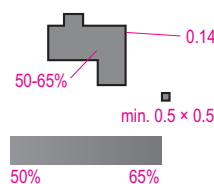

526.2 Canopy

A canopy is a building construction (with a roof), normally supported by pillars, poles or walls, such as passages, gangways, courts, bus stops, gas stations or garages.

Small passable parts of buildings which can not easily be crossed by competitors, shall not be represented on the map and shall be closed during the competition.

Colour: black 20%, black.

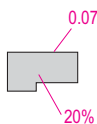

526.3 Pillar

A pillar is an upright shaft or structure of stone, brick or other material, relatively slender in proportion to its height and any shape in section, used as a building support. Pillars smaller than 2 m x 2 m are generally not represented.

Columns of pillars and pillars along buildings are not represented. However, if they are important for navigation and orientation, they can be represented.

Colour: black.

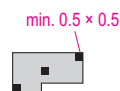

528.1 Area with forbidden access (forbidden to cross)

An area with forbidden access such as a private area, a flower bed, a railway area etc. No feature shall be represented in this area, except very prominent features such as railways, large buildings, or very large trees. Road entrances shall be represented clearly.

Areas with forbidden access totally contained within buildings shall be mapped as being a part of the building.

Colour: yellow 100%, green 50%.

It is forbidden to cross an area with forbidden access!

Competitors violating this rule will be disqualified.

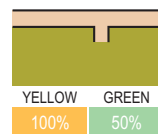

529 Paved area

A paved area is an area with a firm level surfaces such as asphalt, hard gravel, tiles, concrete or the like. It should be bordered (or framed) by the symbol *step or edge of paved area* (529.1). Distinct differences within the paved area can be represented with the symbol *step or edge of paved area* (529.1), if they serve navigation.

Where a paved road, footpath or track goes through a non-urban area, the brown fill-in shall be drawn darker, so that if (x)% brown is used in urban areas, (x+20)% brown shall be used in the non-urban areas, and the line width of the black outline shall be increased from 0.07 to 0.14 mm.

The black border line can be omitted where it is logical (e.g. indistinct/gradual gravel-to-grass transitions).

Colour: brown 0 (white), 10%, 20% or 30% (urban) / 20%, 30%, 40%, 50% (non-urban) (min. 60 lines/cm), black; the colour and the line width shall be the same as for symbol *unpaved footpath or track* (506.1).

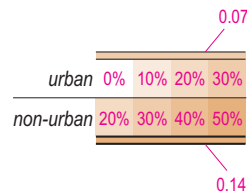

529.1 Step or edge of paved area

A step or an edge of a paved area. Steps of a stairway shall be represented in a generalized manner. Edges within paved areas are generally not represented, unless they serve navigation. The thickness of edge of paved areas shall be enlarged to 0.14 mm in non-urban areas to improve legibility. The thickness of step lines shall always be 0.07 mm.

Colour: black.

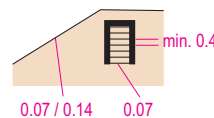

533 Passable pipeline

A pipeline (gas, water, oil, etc.) above ground level which can be crossed over or under.

Colour: black.

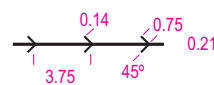

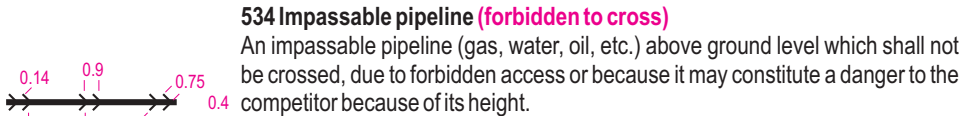

534 Impassable pipeline (forbidden to cross)

An impassable pipeline (gas, water, oil, etc.) above ground level which shall not be crossed, due to forbidden access or because it may constitute a danger to the competitor because of its height.

Colour: black.

It is forbidden to cross an impassable pipeline!
Competitors violating this rule will be disqualified.

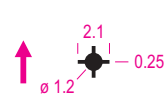

535 High tower

A high tower or large pylon. Very large towers shall be represented in plan shape with the symbol *building* (526.1). The symbol is orientated to north.

Colour: black.



536 Small tower

An obvious small tower, platform or seat. The symbol is orientated to north.

Colour: black.

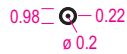

537 Cairn, memorial, small monument or boundary stone

Cairn, memorial, small monument or boundary stone more than 0.5 m high. Large massive monuments shall be represented in plan shape with the symbol *building* (526.1).

Colour: black.

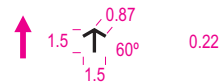

538 Fodder rack

A fodder rack, which is free standing or attached to a tree. The symbol is orientated to north.

Colour: black.



539 Prominent man-made feature

A man-made feature which is significant or prominent. The definition of the symbol shall always be given in the map legend.

Colour: black.



540 Prominent man-made feature

A man-made feature which is significant or prominent. The definition of the symbol shall always be given in the map legend. The symbol is orientated to north.

Colour: black.

5.6 TECHNICAL SYMBOLS



601 Magnetic north line

Magnetic north lines are lines placed on the map pointing to magnetic north. Their spacing shall be 30 mm on the 1:5 000 map and 37.5 mm on the 1:4 000 map so in both scales they represent 150 m on the ground.

North lines may be broken where they obscure small features such as boulders, knolls, cliffs, stream junctions, path ends, etc.

Colour: black or blue.



602 Registration marks

At least three registration marks shall be placed within the frame of a map in a non-symmetrical arrangement. In addition, a colour check should be possible. Colour: all printed colours.

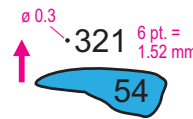

603 Spot height

Spot heights are used for the rough assessment of height differences. The height is given to the nearest metre. The figures are orientated to the north. Water levels are given without the dot.

Colour: black

5.7 OVERPRINTING SYMBOLS

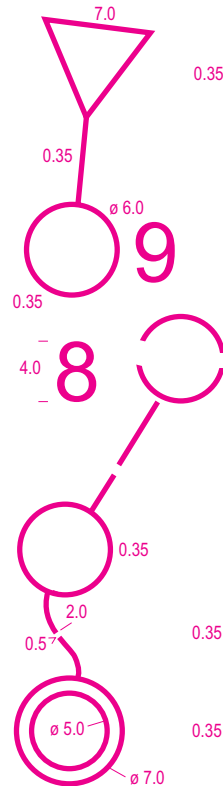

701 Start

The start or map issue point (if not at the start) is shown by an equilateral triangle which points in the direction of the first control. The centre of the triangle shows the precise position of the start point.

Colour: purple.

702 Control point

The control points are shown with circles. The centre of the circle shows the precise position of the feature. Sections of circles should be omitted to leave important detail showing.

Colour: purple.

703 Control number

The number of the control is placed close to the control point circle in such a way that it does not obscure important detail. The numbers are orientated to north.

Colour: purple.

704 Line

Where controls are to be visited in order, the start, control points and finish are joined together by straight lines. Sections of lines should be omitted to leave important detail showing.

Colour: purple.

705 Marked route

A marked route is shown on the map with a dashed line.

Colour: purple.

706 Finish

The finish is shown by two concentric circles.

Colour: purple.

707 Uncrossable boundary (forbidden to cross)

A boundary which it is not permitted to cross. Uncrossable boundaries shall be mapped by using the symbols: *impassable cliff* (201), *impassable body of water* (304.1), *impassable marsh* (309), *impassable wall* (521.1), *impassable fence or railing* (524) or *impassable pipeline* (534) and shall not be overprinted with symbol *uncrossable boundary* (707). This symbol is to be used only for last minute updates to the competition area, as excessive use of purple for indicating barriers is unfortunate.

Colour: purple.

It is forbidden to cross an uncrossable boundary!
Competitors violating this rule will be disqualified.

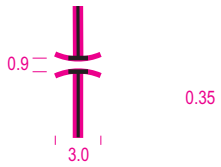

708 Crossing point

A crossing point through or over a wall or fence, or across a road or railway or through a tunnel or an out-of-bounds area is drawn on the map with two lines curving outwards.

If underpasses or tunnels etc. are to be used in a competition, they shall be emphasized with symbol *crossing point* (708) or *crossing section* (708.1).
Colour: purple.

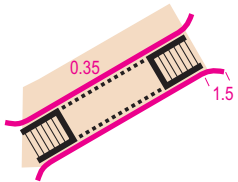

708.1 Crossing section

A crossing section through or over a building, wall or fence, or across a road or railway or through a tunnel or an out-of-bounds area is drawn on the map as a linear object, according to the plan shape.

If underpasses or tunnels etc. are to be used in a competition, they shall be emphasized with symbol *crossing point* (708) or *crossing section* (708.1).
Colour: purple.

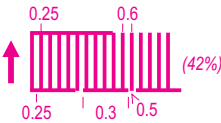

709 Out-of-bounds area (forbidden to cross)

Out of bounds areas are mapped with the symbol *area with forbidden access* (528.1). This symbol shall only be used for last minute updates to the competition map (e.g. for areas that may be dangerous for the competitors during the competition, or very late changes to the competition terrain).

An out-of-bounds area is shown with vertical stripes.

A bounding line may be drawn if there is no natural boundary, as follows:

- a solid line indicates that the boundary is marked continuously (tapes, etc.) on the ground,
- a dashed line indicates intermittent marking on the ground,
- no line indicates no marking on the ground.

Colour: purple.

It is forbidden to cross an out-of-bounds area!

Competitors violating this rule will be disqualified.



712 First aid post

The location of a first aid post.

Colour: purple.



713 Refreshment point

The location of a refreshment point which is not at a control or along the marked route.

Colour: purple.



714 Temporary construction or closed area (forbidden to cross)

Obvious temporary constructions like platforms for spectators and speaker, closed area for spectators, outside restaurant areas, etc. shall be represented in plan shape.
Colour: purple 50%.

It is forbidden to enter a temporary construction or closed area!

Competitors violating this rule will be disqualified.

6 PRECISE DEFINITION OF SYMBOLS

Note: dimensions are specified in mm.

All drawings are magnified (10×) for clarity. The center of gravity is marked (x) when it is not unambiguous.

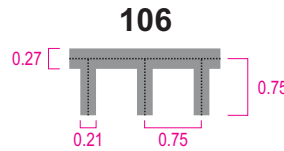

106

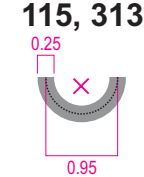

115, 313

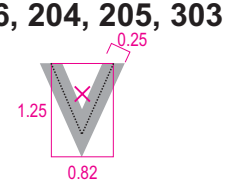

116, 204, 205, 303

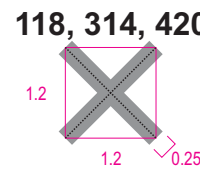

118, 314, 420

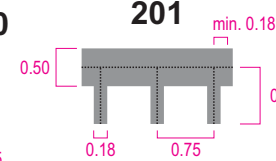

201

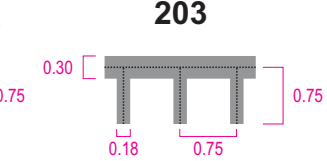

203

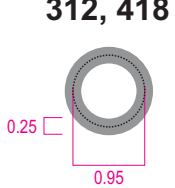

312, 418

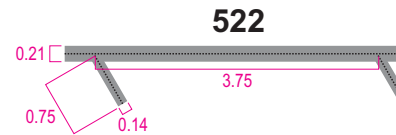

522

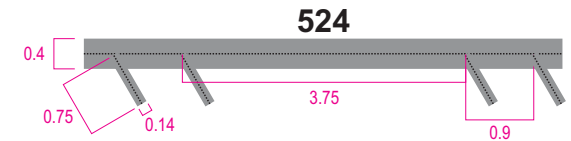

524

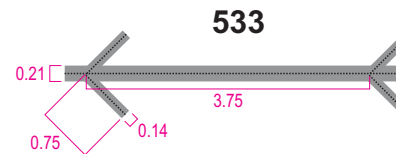

533

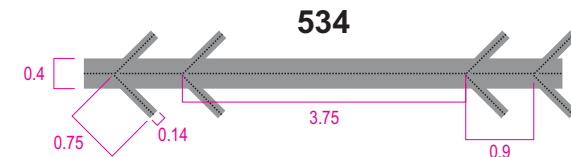

534

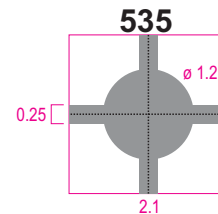

535

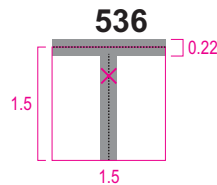

536

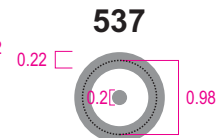

537

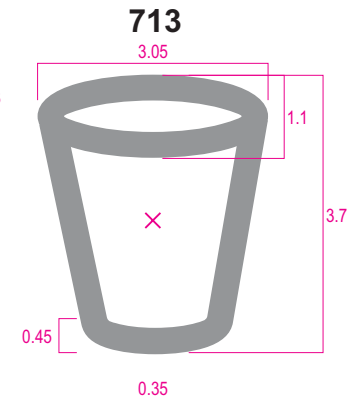

713

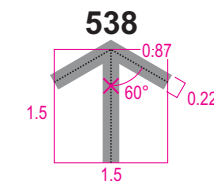

538

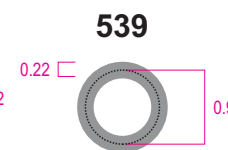

539

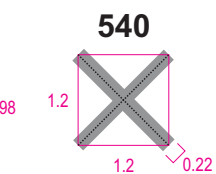

540